

Data Sheet



Article number: 2072221220BSW

Description: E+G
Indexing plunger GN 722.2-12-20-B-SW

Measures

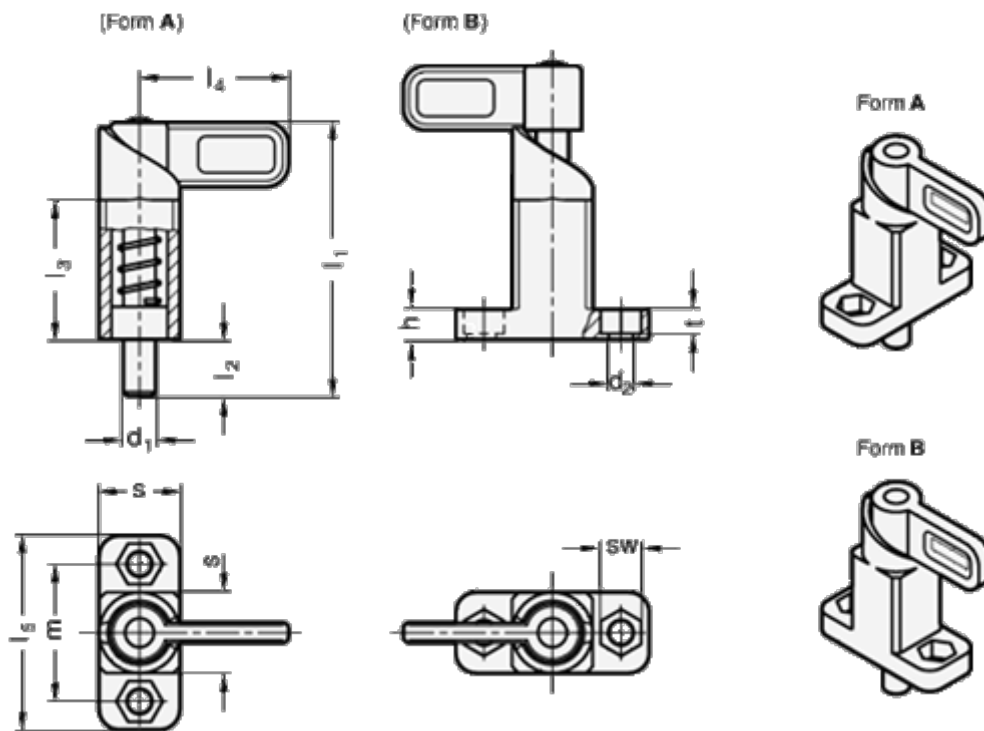

A/F = 10	l5	= 48
d = 12	m	= 34
d2 = 6.1	s	= 20
h = 7.5	Spring load end N	= 55
l1 = 68	Spring load initial N	= 16
l2 = 14	t	= 6.1
l3 = 35		
l4 = 37		